

Liebherr Customer Service

Your Reliable Service Partner

EN

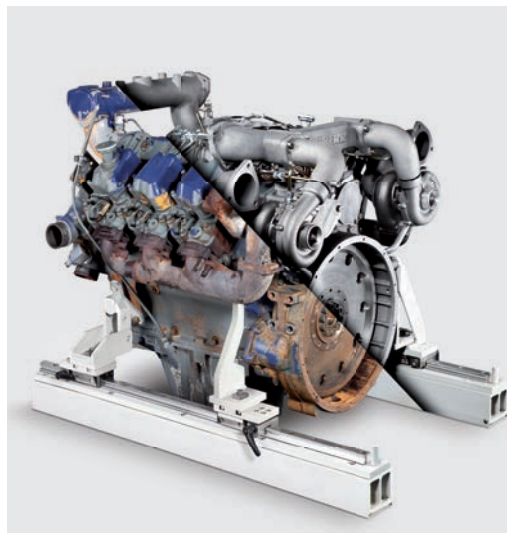

LIEBHERR



**Worldwide
at Your Service**

Our Customer
Service Centres

**Service Excellence
Our Commitment to You**

Technical Support

**Field Service
for your Convenience**

Regular Service for
Higher Value

Application and
Process Technology

**Efficiency and Reliability Through-
out the Lifetime of your Machine**

Feel the Pulse of Innovation



**Availability of Parts
and Components**

Original Quality from
Liebherr

**MyLiebherr - Your Personal
Customer Portal**

Online Liebherr Service World

**Experience and
Know-how Transfer**

Higher Performance Through
Better Training

Worldwide at Your Service

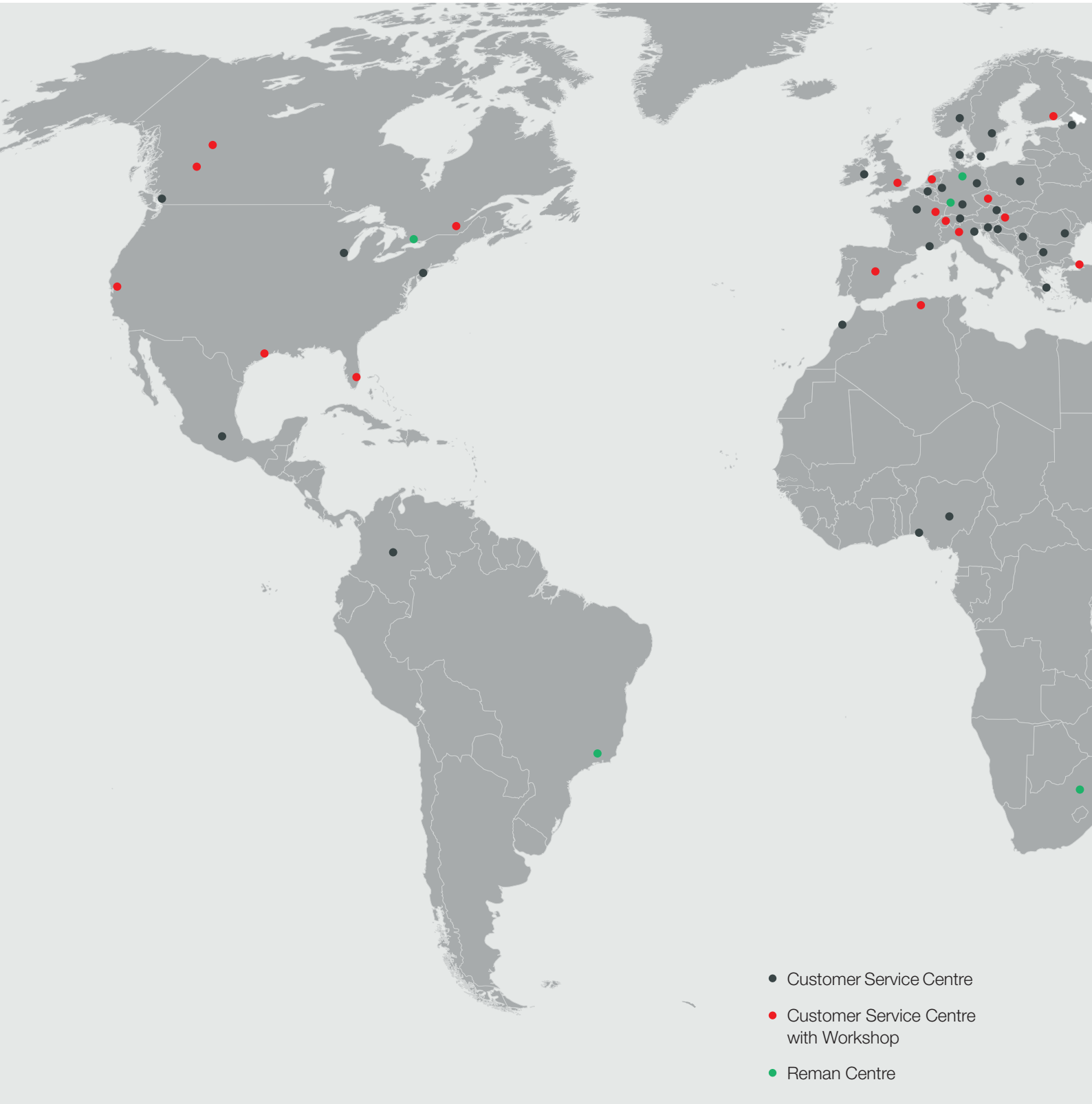

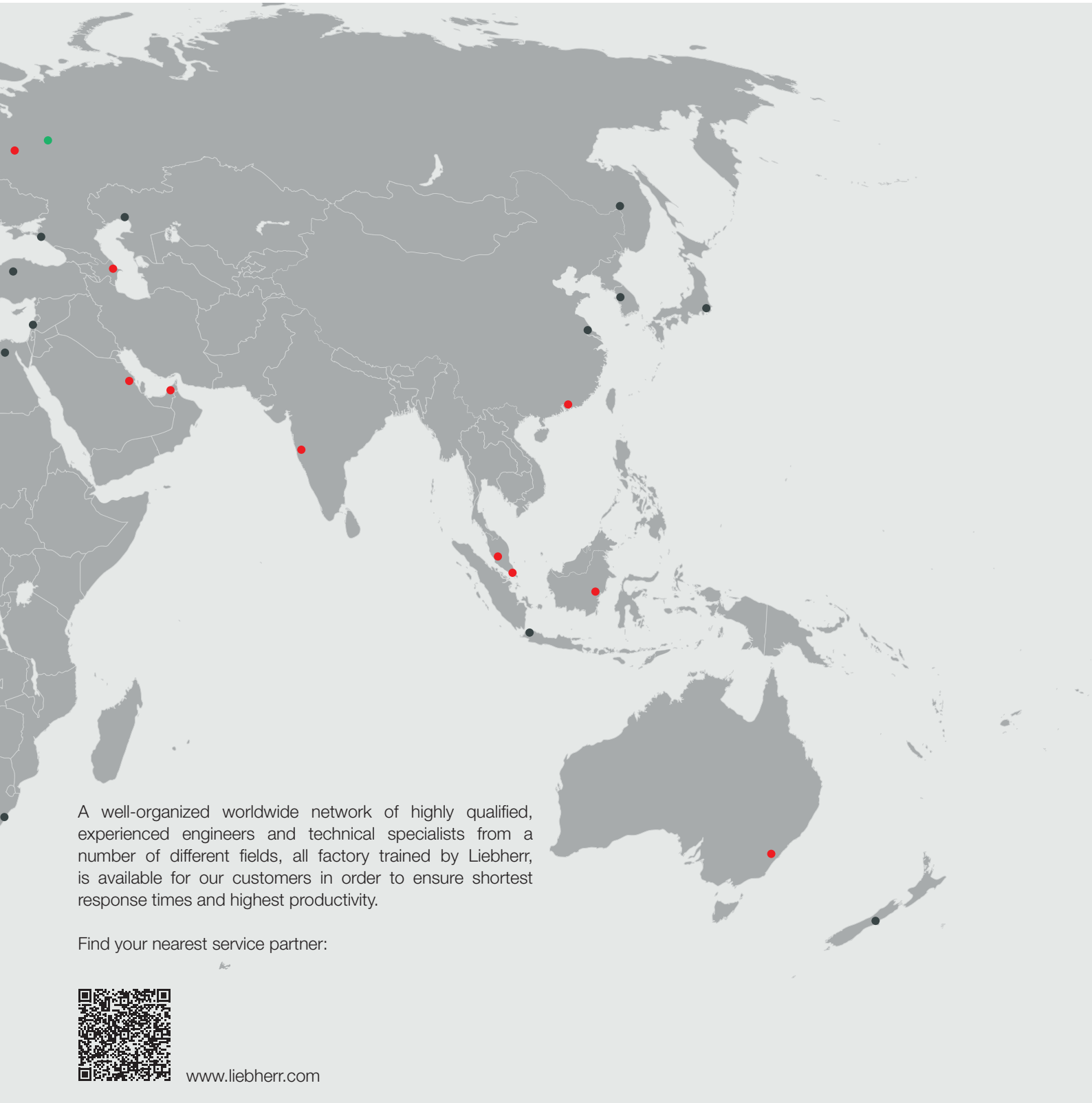

A well-organized worldwide network of highly qualified, experienced engineers and technical specialists from a number of different fields, all factory trained by Liebherr, is available for our customers in order to ensure shortest response times and highest productivity.

Find your nearest service partner:



www.liebherr.com

Service Excellence

Our Commitment to You



Competent and Trustworthy

Based on many years of experience we provide our customers with effective assistance and support and will continue to do so in the future.

Technical Support

Specially trained technical advisers are stationed worldwide in order to provide quick and reliable support to our customers.

Your benefit:

- optimal efficiency of your machines
- direct contact with Liebherr staff

Real Time Service and Remote Service

Using LiDAT® Teleservice, Liebherr service engineers can log directly on to your machine so providing instant support and immediate fault analysis online.

Your benefit:

- lower costs
- minimum downtime



Fleet Management

Based on proven LiDAT data transmission technology, the monitoring system provides valuable information regarding the status of your Liebherr fleet. This enables efficient management, as well as optimal operation, maintenance scheduling and remote supervision.

Predictive Maintenance

The integrated telematic system allows for the recording and reporting of data regarding individual machine conditions. This detailed analysis supports predictive maintenance and avoids unscheduled downtime.

Monitoring and Diagnosis

Our highly qualified service personnel supports you worldwide by monitoring deployed Liebherr machines and preparing diagnoses if required. By using state-of-the-art diagnostic tools and Remote Service Software the availability of your machine is permanently ensured.

Field Service for your Convenience



Reliable and Cooperative

The continuous improvement and expansion of the service network is part of our commitment to offer the best possible support to customers worldwide.

Regular Service for Higher Value

In order to ensure the best possible condition of machines, our qualified personnel carry out tailor-made inspections, which include safety checks and load tests in accordance with directives, and can recommend maintenance programmes to meet your specific requirements.



Preventive Maintenance

Regular equipment inspections and preventive maintenance increase the overall availability of your machine and, at the same time, significantly reduce the probability of major repairs.

Inspection Monitoring

Pro-active machine monitoring and analyses provide concise information about the condition of your machine and ensure that high performance and precision can be maintained.



Welding and Steel Construction Specialists

Our Service Centre Steel Construction comprises a team of internationally certified specialists focusing on steel structure repairs and welding technology. They provide a full range of services beginning with inspections on site and the competent planning of repairs, up to the execution of work involved.

Electric Toolbox

The modularly compiled Electric Toolbox offers a mobile, robust and orderly product solution for your daily service routine and is available from your service partner.

- Single source
- Optimally equipped
- Straightforward documentation

Field Service for your Convenience



Consistency and Long-Term Backup

With Liebherr you have not only chosen a top quality machine but also a reliable and trustworthy service partner. Our professional field engineers assist from the moment the machine leaves the factory and accompany it throughout its whole service life.

Application and Process Technology

The application of sometimes very complex technologies and the correct choice of suitable equipment require special knowledge and practical experience. Our application specialists use their wide experience in various working methods and processes in order to get the most from your machine - maximum utilization for maximum performance.



Machine Consulting

In combination with the choice of the most suitable machine, our application specialists also provide advice regarding the best choice of attachments and respective tools in consideration of site conditions. The aim is to optimize fuel-consumption and minimize wear and tear.

Application and Performance Optimization

Thanks to the detailed communication of new technological features, our customers are always well-informed about the latest developments and can so increase performance, improve operative safety, or comply with new directives.



Standby and Service Agreements

We provide technicians that remain permanently on site to supervise maintenance, optimize applications and generally ensure high availability of the machines. Individually tailored service agreements can also be arranged under close consideration of specific requirements.

Oil Analysis

In order to safeguard the oil quality and to determine the optimum oil-change intervals, we recommend regular analysis of used oils to maintain the condition of the machine, significantly extend the oil change intervals and so help the environment. Our engineers ensure that oil samples are taken correctly for reliable results. A separate brochure provides more details on this subject.

Efficiency and Reliability Throughout the Lifetime of your Machine



Innovative and Dynamic

The wide range of upgrades maintains the high level of productivity and value of your machines throughout their long lifetime.

Feel the Pulse of Innovation

We offer a range of packages incorporating new technologies and innovative designs. Service activities extend from the repair and exchange of single parts and components up to the complete overhaul of machines.

Your advantage:

- flexible solutions for changing work practices
- improved cost efficiency
- extended lifetime of your machine saves new procurement
- increased performance and residual value
- familiarity with existing machines saves renewed training costs



Upgrades and Retrofits

- Health & Safety
- Eco & Comfort
- Cost-Saving & Performance
- Upgrade & Improvement

Workshop Service

Our modern workshops are located throughout the world in order to provide component and machine repairs close at hand.

Machine Overhauls

Second-hand or overhauled machines are often an inexpensive and economic alternative. Despite low investment, quality and service need not be forfeited.

Availability of Parts and Components



Structured And Effective

The availability of cost-effective new parts and the Reman Program is ensured over the lifetime of your machine.

Original Quality from Liebherr



Liebherr Original Parts

Our service includes comprehensive technical support to determine the ideal parts solution. Liebherr original parts are optimally suited to Liebherr machines and fulfil the highest quality standards and so significantly increase cost-effectiveness and value retention.

Our service to you:

- strategically located stocks worldwide
- fast distribution service
- long availability of parts

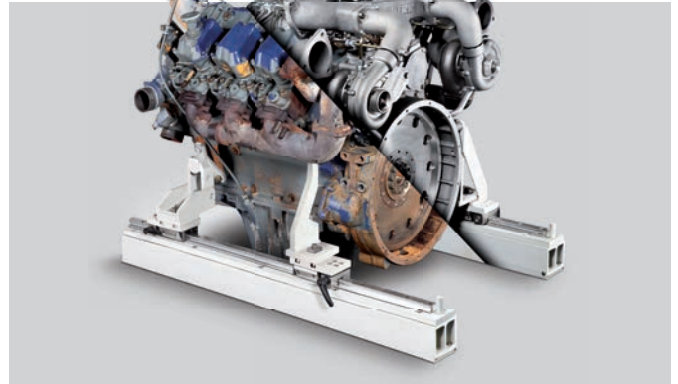

Reman Program

Economic solutions for machines of all ages are the aim of our Reman Program. We offer perfectly matched three-stage reconditioning of components: exchange components, general overhauls and repairs.

Our service to you:

- exchange of all worn parts with original parts
- fixed prices regardless of extent of work required
- complete new part warranty on whole component



Filter and Service Kits

Our original filter kits are optimally harmonized for each individual type of machine and their respective service interval.

Our service to you:

- simplified ordering processes
- more cost-effective than individual orders
- no missing parts for service activities



Liebherr Lubricants and Operating Fluids

Our high quality lubricants and operating fluids help to maintain the performance of your Liebherr machines with lasting effect.

Our service to you:

- suitable for all Liebherr machines and also those of other manufacturers
- high environmental sustainability
- continuous research and development

MyLiebherr

Your Personal Customer Portal



Anytime, Anywhere

MyLiebherr is your ticket to the Liebherr online service world. Thanks to the MyLiebherr customer portal, you will benefit from comprehensive services and additional features for your Liebherr machines.

Online Liebherr Service World



Spare Parts Catalogue

The interactive structure of the catalogue shows your machines including drawings, parts lists and quantities required. Additionally you can use a convenient search tool. Using keywords you can identify your parts even more quickly.

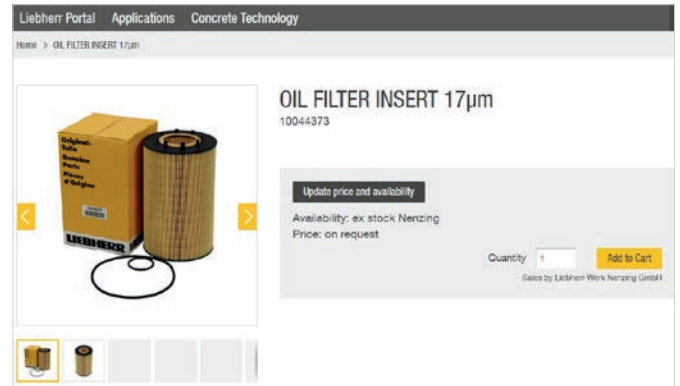

Parts Shop

Liebherr parts, fluids and accessories can be ordered from your service partner at any time using the online shop, no matter where you are.

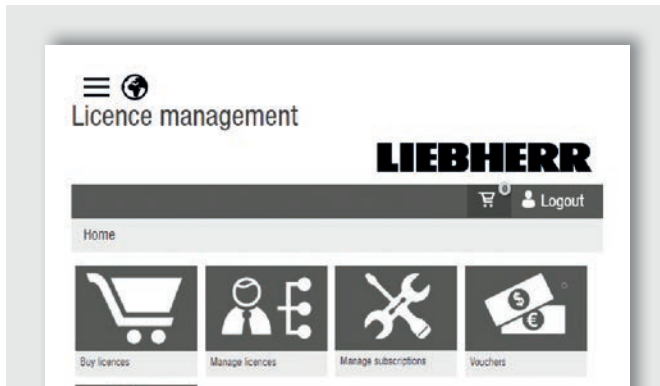

Licence Shop

Various licences for digital services can be quickly and easily ordered, paid for and allocated online: so you can start immediately.

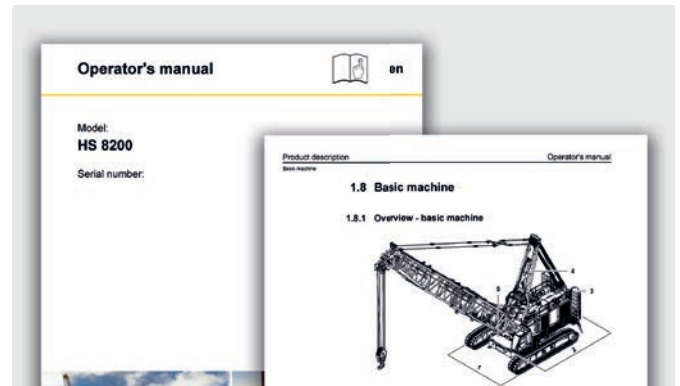

Documentation

The latest version of your machine documentation, e.g. Operator's Manual or Technical Information, is available online and can be downloaded free of charge.

Simply log on
and use MyLiebherr:
www.myliebherr.com



Experience and Know-how Transfer



Practical Advice from Professionals for Professionals

With appropriate training in daily operations we can help you to achieve even better results.

Higher Performance Through Better Training

Personnel training is of utmost importance in order to create a sustainable awareness for efficient and safe machine operation. We are not only committed to training our own service personnel but also our customers' staff. Our application specialists are at your disposal for training purposes directly on jobsites worldwide.

Your benefit:

- safer machine operation
- higher productivity through increased skills
- minimum downtime
- less wear and tear
- reduced fuel consumption
- time savings



Training Centres

We offer a broad spectrum of training for both operators and maintenance staff. Programmes are prepared individually and specifically tailored to customer machines.

Liebherr Simulators

Highly effective practical training under diverse environmental conditions without risk of injury or damage to surroundings. Critical situations can be practised in a safe environment.

Training on Site

Ranging from the assembly or disassembly of the machine, through upgrades and retrofits, up to the optimization of the jobsite itself, we offer a broad spectrum of training possibilities including our own digital solutions.

The Liebherr Group of Companies



Wide Product Range

The Liebherr Group is one of the largest construction equipment manufacturers in the world. Liebherr's high-value products and services enjoy a high reputation in many other fields. The wide range includes domestic appliances, aerospace and transportation systems, machine tools and maritime cranes.

Exceptional Customer Benefit

Every product line provides a complete range of models in many different versions. With both their technical excellence and acknowledged quality, Liebherr products offer a maximum of customer benefits in practical applications.

State-of-the-art Technology

To provide consistent, top quality products, Liebherr attaches great importance to each product area, its components and core technologies. Important modules and components are developed and manufactured in-house, for instance the entire drive and control technology for construction equipment.

Worldwide and Independent

Hans Liebherr founded the Liebherr family company in 1949. Since then, the family business has steadily grown to a group of more than 130 companies with nearly 44,000 employees located on all continents. The corporate headquarters of the Group is Liebherr-International AG in Bulle, Switzerland. The Liebherr family is the sole owner of the company.

www.liebherr.com